

# Manitowoc Crane Group

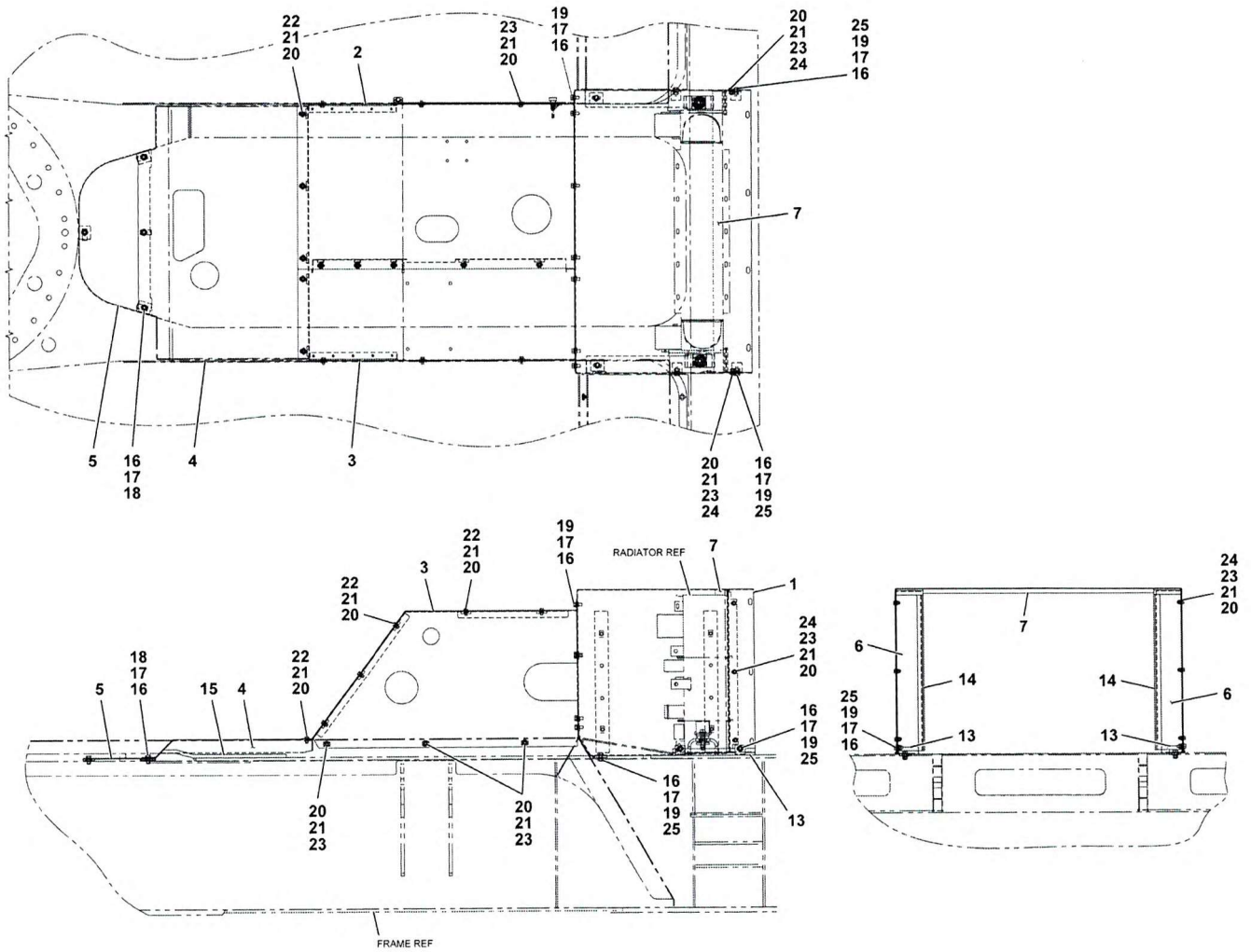

2159810166

(SHEET 2 OF 2)

# Manitowoc Crane Group

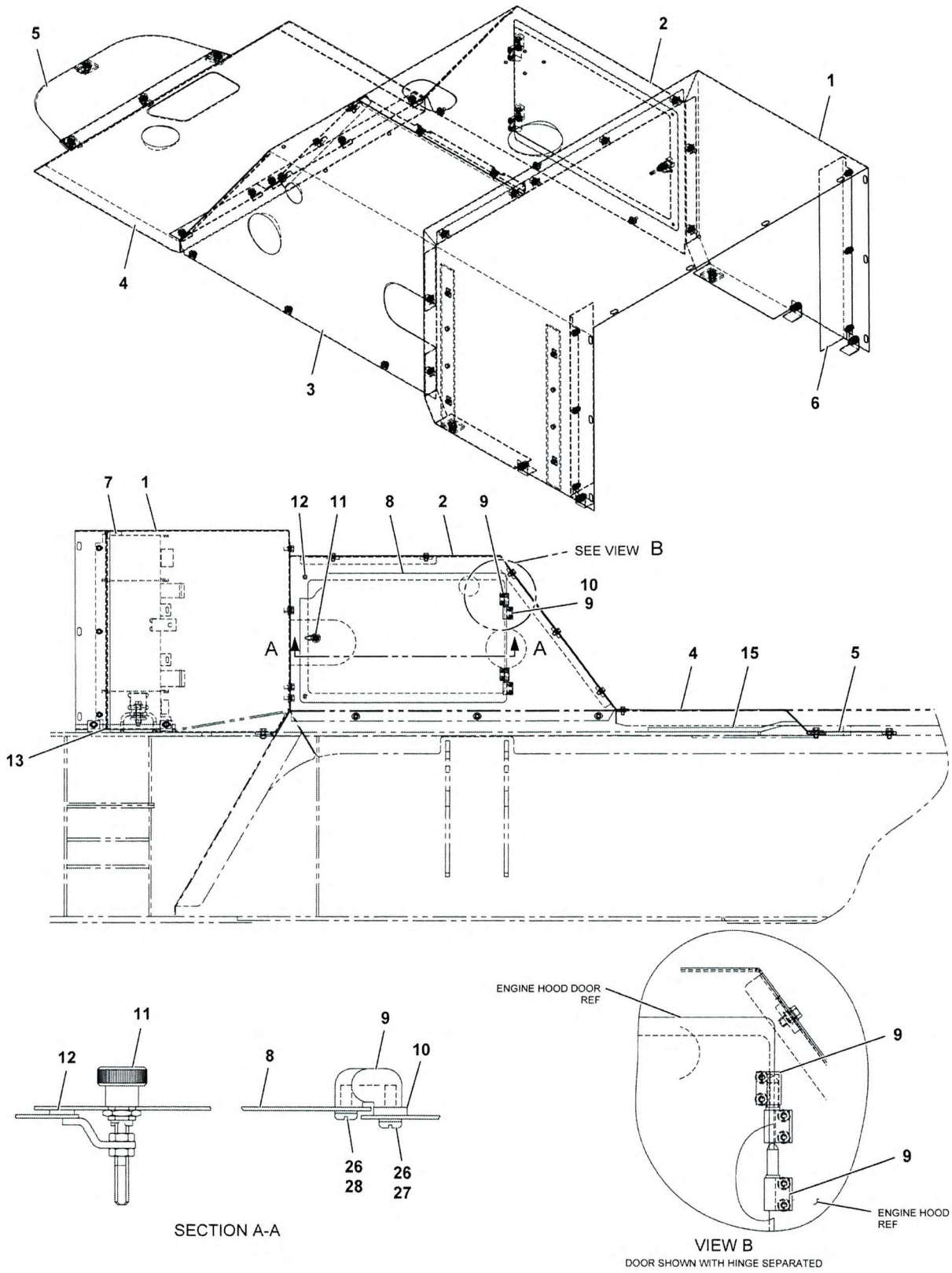

2159810166

(SHEET 1 OF 2)

Page 346